

PRODUCT TECHNICAL SHEET

Collection : **TRIO**

Ref. : **1001.--.98**

Robinet double service équerre

Dubbele dienstkraan recht model

Double service tap, square model

Picture

Product details

Weight : 0,6 kg



Internal mechanism : 1/3 turn compression valve

Technical drawing

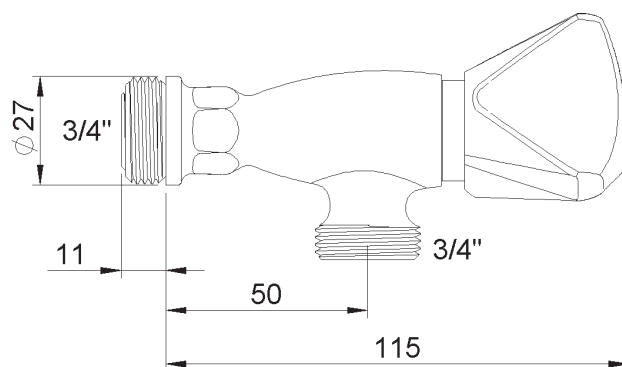

RAO.V01